



EON 208P PORTABLE PA

USER'S GUIDE



Contents

Section 1: Important Safety Instructions	3 - 4
Section 2: Precautions	5
Section 3: Declaration of Conformity	6
Section 4: Introduction to the EON208P PA System	7 - 11
Section 5: System Specifications	12
Section 6: Cables and Connectors	13
Section 7: Contact Information	14
Section 8: Warranty Information	15

Section 1: Important Safety Instructions

1. Read these instructions.
2. Keep these instructions.
3. Heed all warnings.
4. Follow all instructions.
5. Do not use this apparatus near water.
6. Clean only with dry cloth.
7. Do not block any ventilation openings. Install in accordance with the manufacturer's instructions.
8. Do not install near any heat sources such as radiators, heat registers, stoves, or other apparatus (including amplifiers) that produce heat.
9. Do not defeat the safety purpose of the polarized or grounding-type plug. A polarized plug has two blades with one wider than the other. A grounding-type plug has two blades and a third grounding prong. The wide blade or the third prong is provided for your safety. If the provided plug does not fit into your outlet, consult an electrician for replacement of the obsolete outlet.
10. Protect the power cord from being walked on or pinched, particularly at plugs, convenience receptacles, and the point where they exit from the apparatus.
11. Only use attachments/accessories specified by the manufacturer.
12. Use only with the cart, stand, tripod, bracket, or table specified by the manufacturer, or sold with the apparatus. When a cart is used, use caution when moving the cart/ apparatus combination to avoid injury from tip-over.
13. Unplug this apparatus during lightning storms or when unused for long periods of time.
14. Refer all servicing to qualified service personnel. Servicing is required when the apparatus has been damaged in any way, such as power supply cord or plug is damaged, liquid has been spilled or objects have fallen into the apparatus, the apparatus has been exposed to rain or moisture, does not operate normally, or has been dropped.
15. Service Instruction in Owner's Manual: "CAUTION - THESE SERVICING INSTRUCTIONS ARE FOR USE BY QUALIFIED SERVICE PERSONNEL ONLY. TO REDUCE THE RISK OF ELECTRIC SHOCK DO NOT PERFORM ANY SERVICING OTHER THAN THAT CONTAINED IN THE OPERATING INSTRUCTIONS UNLESS YOU ARE QUALIFIED TO DO SO."
16. To completely disconnect this apparatus from the AC mains, disconnect the power supply cord plug from the AC receptacle.
17. "WARNING – TO REDUCE THE RISK OF FIRE OR ELECTRIC – SHOCK, DO NOT EXPOSE THIS APPARATUS TO RAIN OR MOISTURE."
18. Do not expose this equipment to dripping or splashing and ensure that no objects filled with liquids, such as vases, are placed on the equipment.
19. The mains plug of the power supply cord shall remain readily operable.



Care and Cleaning

EON208P systems may be cleaned with a dry cloth. Do not get moisture into any of the openings in the system. Ensure that the system is unplugged from the AC outlet before cleaning.

THIS APPARATUS CONTAINS POTENTIALLY LETHAL VOLTAGES. TO PREVENT ELECTRIC SHOCK OR HAZARD, DO NOT REMOVE CHASSIS, MIXER MODULE OR AC INPUT COVERS. NO USER SERVICEABLE PARTS INSIDE. REFER SERVICING TO QUALIFIED SERVICE PERSONNEL.

Section 2: Precautions



The EON208P PA system covered by this manual is not intended for use in high moisture environments. Moisture can damage the speaker cone and surround and cause corrosion of electrical contacts and metal parts. Avoid exposing the speakers to direct moisture. Keep speakers out of extended or intense direct sunlight. The driver suspension will prematurely dry out and finished surfaces may be degraded by long-term exposure to intense ultra-violet (UV) light. The EON208P PA system can generate considerable energy. When placed on a slippery surface such as polished wood or linoleum, the speaker may move due to its acoustical energy output. Precautions should be taken to assure that the speaker does not fall off a stage or table on which it is placed.

Stand Mounting Safety Precautions

The EON208P speakers contain a 36 mm receptacle cup to allow mounting on tripod stands or on a pole over subwoofers. When using stands or poles, be sure to observe the following precautions:

- Check the stand or pole specification to be certain the device is designed to support the weight of the speaker. Observe all safety precautions specified by the manufacturer.
- Always verify that the stand (or subwoofer/pole) is placed on a flat, level and stable surface and be sure to fully extend the legs of tripod type stands. Position the stand so that the legs do not present a trip hazard.
- Route cables so that performers, production crew, and audience will not trip and topple the speakers over.
- Inspect the stand (or pole and associated hardware) before each use and do not use equipment with worn, damaged or missing parts.
- Do not attempt to place more than one EON208P series speaker on a stand or pole.
- Always be cautious in windy, outdoor conditions. It may be necessary to place additional weight (i.e. sandbags) on the base of the stand to improve stability. Avoid attaching banners or similar items to any part of a speaker system. Such attachments could act as a sail and topple the system.
- Unless you are confident that you can handle the weight of the speaker, ask another person to help you get it onto the tripod stand or pole.

Hearing Damage, Prolonged Exposure to Excessive SPL

The EON208P system is capable of generating sound pressure levels (SPL) sufficient to cause permanent hearing damage to performers, production crew and audience members. Caution should be taken to avoid prolonged exposure to SPL in excess of 90 dB.

WATCH FOR THESE SYMBOLS!

The exclamation point within an equilateral triangle is intended to alert the user to the presence of important operating and maintenance (Servicing) instructions in the literature accompanying the product.

The lightning flash with the arrowhead symbol within an equilateral triangle is intended to alert the user to the presence of un-insulated "Dangerous Voltage" within the products enclosure that may be of sufficient magnitude to constitute a risk of electric shock to persons.



Section 3: EON208P PA System Declaration of Conformity

This equipment complies with the EMC directive 89/336/EEC
Modified by
92/31/EEC
93/68/EEC
98/13/EEC and LVD 73/23/EEC modified by 93/68/EEC



This product meets safety standards:

EN60065:2002

UL6500 7th Edition: 2003

UL 60065 - STANDARD FOR AUDIO, VIDEO AND SIMILAR ELECTRONIC
APPARATUS - SAFETY REQUIREMENTS - Edition 7 - Revision Date 2007/12/11

CSA C22.2 NO 60065-03 - AUDIO, VIDEO AND SIMILAR ELECTRONIC
APPARATUS - SAFETY REQUIREMENTS - Edition 1 - Revision Date 2006/04/01

IEC 60065 - AUDIO, VIDEO AND SIMILAR ELECTRONIC APPARATUS -- SAFETY
REQUIREMENTS - Edition 7.1 - Issue Date 2005/12/01

And EMC Standards

EN55103-1 (E2)

EN55103-2 (E2)

FCC Compliance Notice

This device complies with part 15 of the FCC rules. Operation is subject to the following two conditions: (1) This device may not cause harmful interference, and (2) this device must accept any interference received, including interference that may cause undesired operation.

CAUTION: Changes or modifications not expressly approved by the party responsible for compliance could void the user's authority to operate the equipment.

NOTE: This equipment has been tested and found to comply with the limits for a Class A digital device, pursuant to part of the FCC Rules. These limits are designed to provide reasonable protection against harmful interference in a residential installation. This equipment generates, uses, and can radiate radio frequency energy and, if not installed and used in accordance with the instruction manual, may cause harmful interference to radio communications. However there is no guarantee that the interference will not occur in a particular installation. If this equipment does cause harmful interference to radio and television reception, which can be determined by turning the equipment off and on, the user is encouraged to try to collect the interference by one or more of the following measures.

- Reorient or relocate the receiving antenna
- Increase the separation between the equipment and receiver
- Connect the equipment into an outlet on a circuit different from that to which the receiver is connected
- Consult the dealer or an experienced radio/TV technician for help

Section 4: Introduction to the EON208P PA System

Thank you for choosing the JBL EON208P PA system. The EON208P is a self-contained, portable PA system featuring multiple input channels with individual tone controls, Bluetooth® audio streaming, reverb and convenient output routing capabilities that allow the user to integrate the system into any number of audio environments. And with its lightweight and ergonomic design, the EON208P is perfect for situations where ease and portability are just as important as quality and flexibility.

Included in the EON208P package are:

- 2 JBL professional speakers
- 1 AKG vocal microphone, 1 microphone cable and 1 microphone clamp
- 1 center housing with powered mixer and compartment for storage of speaker cables and microphone
- 1 pair of unshielded speaker cables
- 1 power cable
- User's guide

GETTING STARTED

1. Remove EON208P system from the carton.
2. Detach speakers from center powered mixer section.

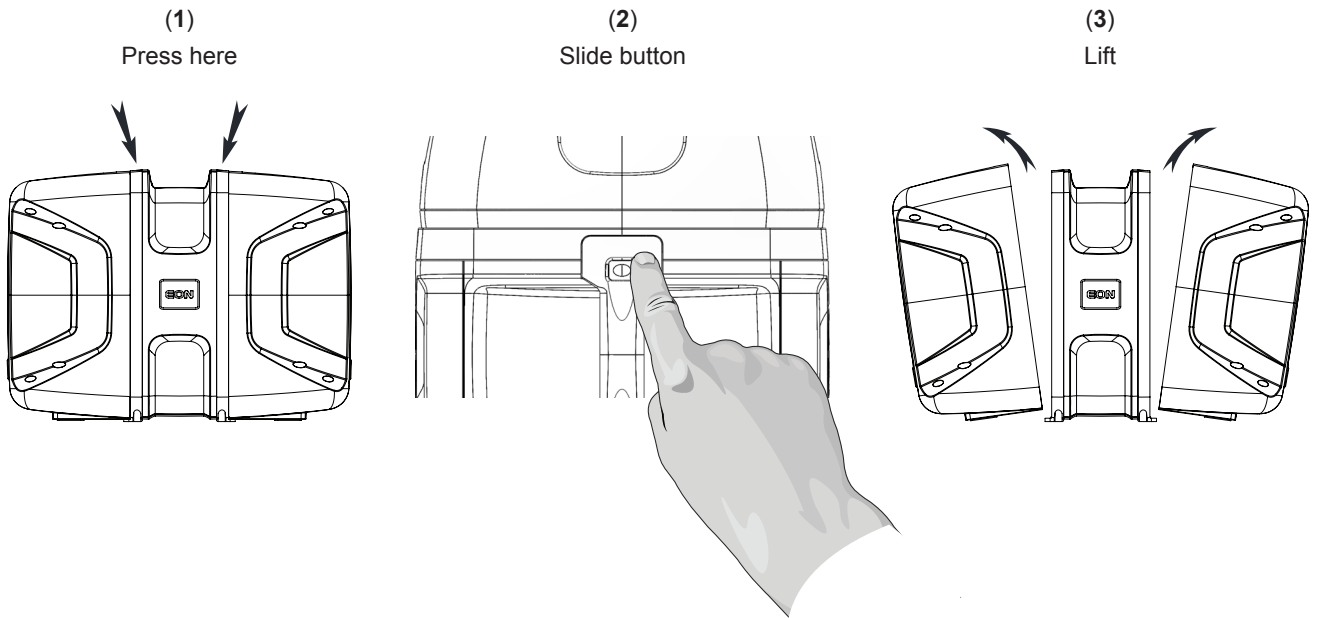

3. If you have purchased speaker stands, you can place the speakers on the stands utilizing the pole mount adaptor built into the EON208P speaker cabinets.

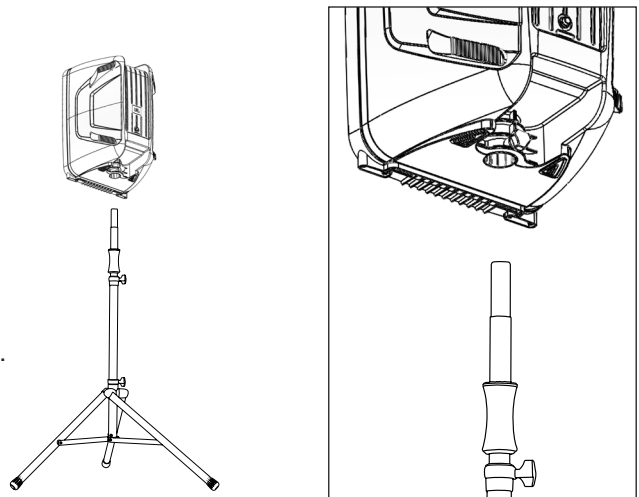

4. Connect the Mixer Module to the Speakers

On the back side of the mixer you will notice two ¼" phone jacks – these are your speaker output jacks. Take the speaker cables and connect them from these jacks to the jacks on the back of the speakers.

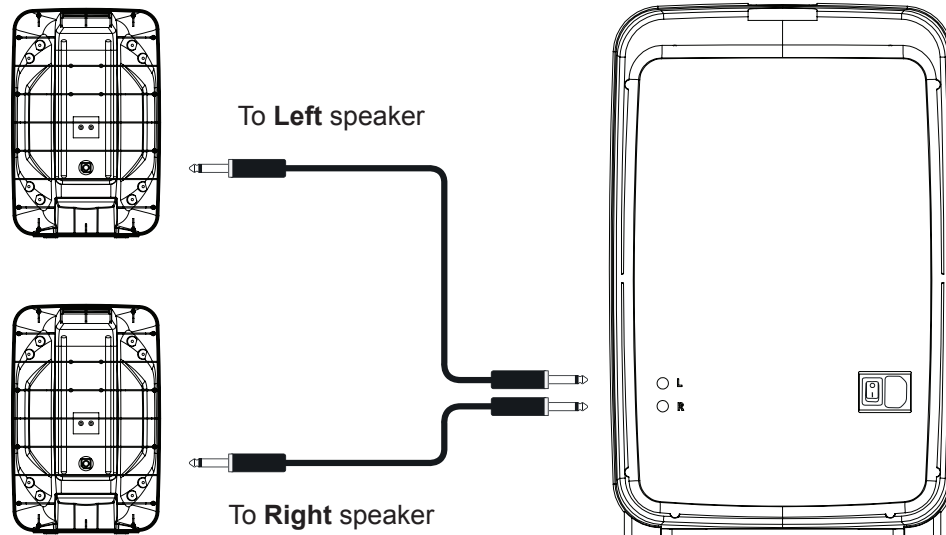

5. Connecting the AC Power Cable

Connect the female end of the power cable to the mixer and plug the male end into the wall socket or extension cord. Turn the "MASTER VOLUME" control to "0". Now turn the power switch to the "on" position. You should see the "POWER" indicator illuminated. **At this point you are ready to bring in an audio signal and hear the signal amplified by the system.**

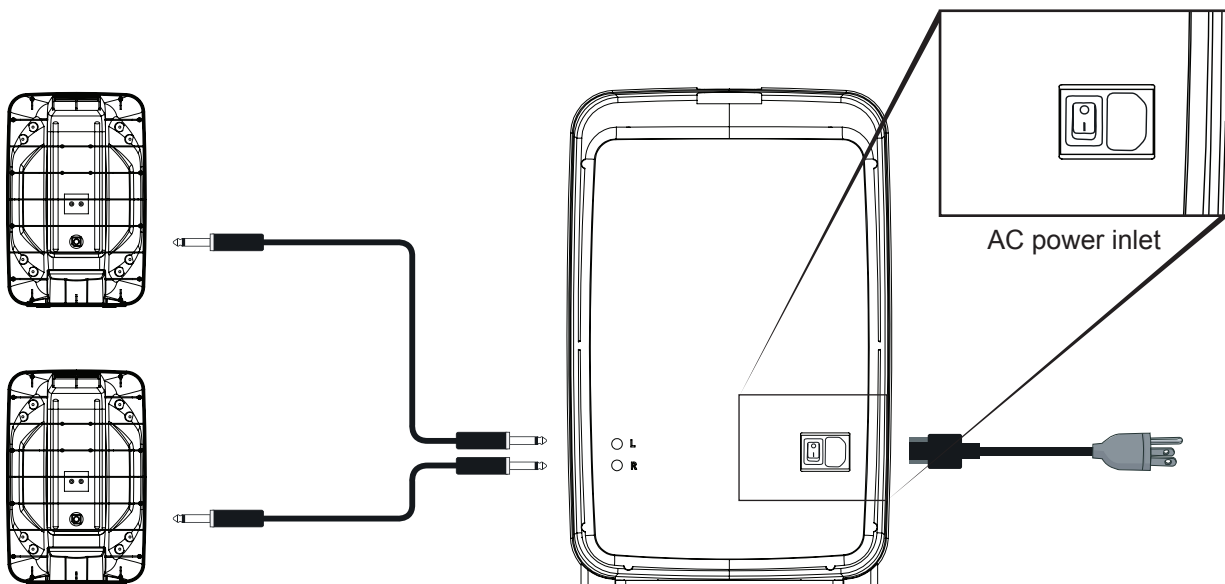

Getting Acquainted with the EON208P Powered Mixer

This part of the EON208P system houses the mixing board and power amplifier. You will connect all of the microphones, musical instruments, Bluetooth® audio device, external sound sources (like MP3 or CD players), in addition to any recording devices or additional speakers like a personal monitor, subwoofer or "Front of House" feed.

The Basics

The mixing board is actually a very simple device. A "mixing board" brings audio sources "in" (through the inputs) and routes the signal to the outputs (MASTER VOLUME/SPEAKER OUTPUTS or MONITOR OUTPUTS). The mixer controls enable the user to affect the tone and/or volume in addition to routing the signal and adding reverb to individual input sources.

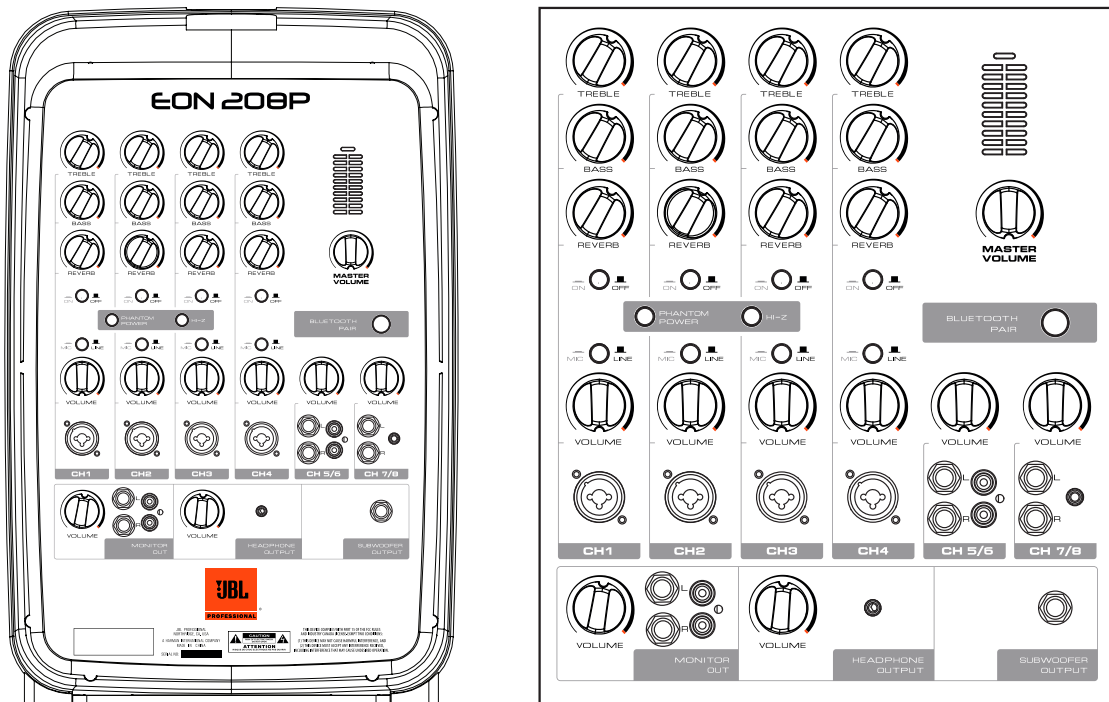

Let's look at the "inputs" first:

AUDIO INPUTS

All of the inputs will route to the speakers and to the MONITOR OUTPUT SECTION.

MONO MIC/LINE INPUTS

Moving from left to right there are 4 identical input strips comprised of (from top to bottom) a treble control, bass control, reverb control, reverb on/off button, volume control, mic/line selector and a XLR ¼" combination connector.

BLUETOOTH INPUT

The EON208P comes equipped with the ability to stream Bluetooth audio. To connect a Bluetooth device first press the "Bluetooth Pair" button on the back of the device. Then select "EON208P" from the source device to complete the pairing. Once paired, audio can be streamed from the connected device.

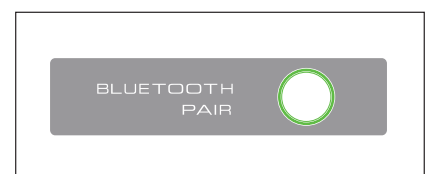

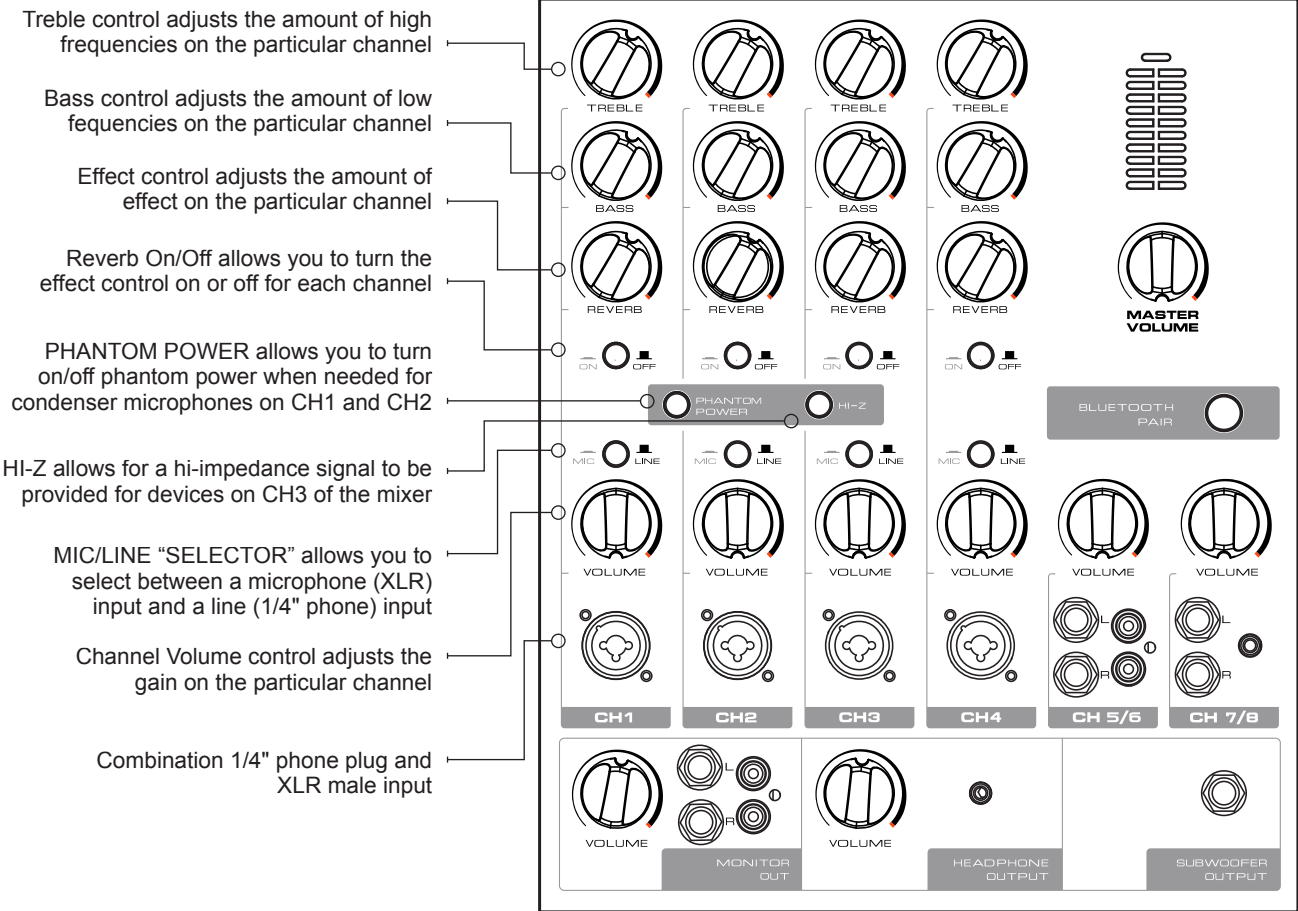

STEREO INPUTS

The EON208P has two stereo inputs and these are used primarily for MP3 or CD players but could be used with the stereo output of an electronic keyboard, instrument pre-amp or processor, or an electronic drum machine. The inputs labeled "CH 5/6" offer the option of using 1/4" phone plugs or RCA plugs and this channel has a volume control. The inputs labeled "CH 7/8" offer the option of using 1/4" phone plugs or a 3.5 mm stereo input typically found on personal music players and this channel has a volume control. This is the best way to control the volume of the unit plugged into this input.

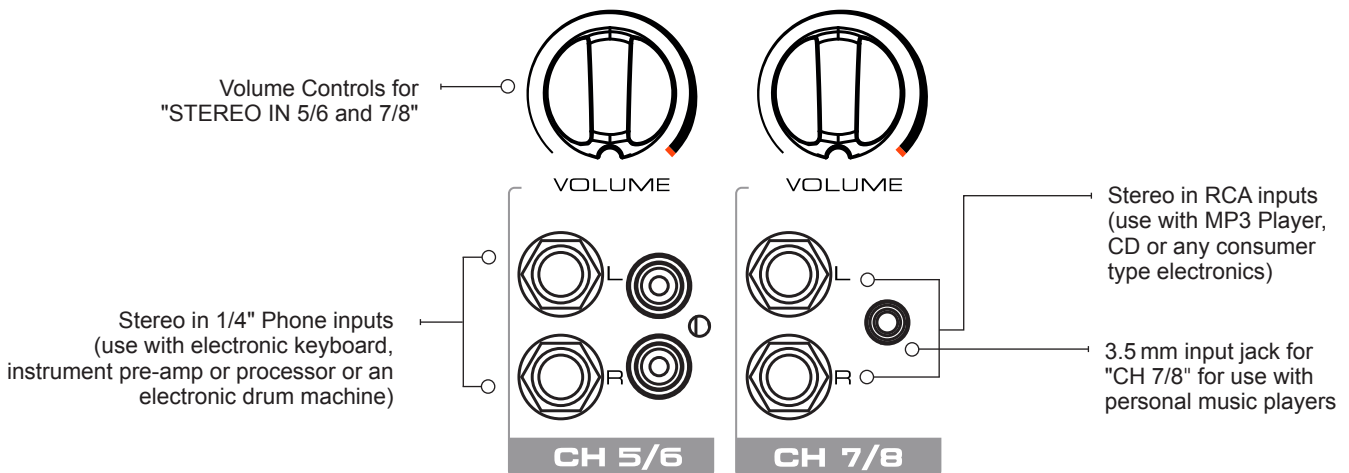

STEREO OUTPUTS: We've brought signals into the mixer now let's send them somewhere...The EON208P has Left and Right 1/4" outputs:

1. LEFT/RIGHT speaker outputs -

These outputs should only be connected to the EON208P speakers and under no condition should they be connected to the input of another electronic device. These outputs carry power and as such could damage the electronic device. Only use "unshielded" speaker cables (like the cables provided with your EON208P).

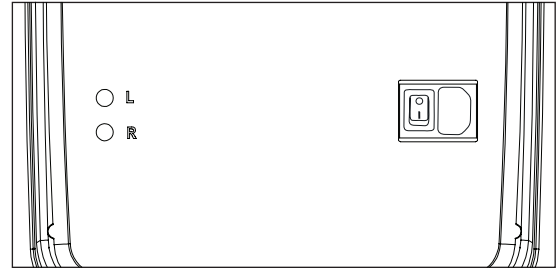

2. MONITOR OUTPUTS

These 1/4" or RCA outputs allow you to route the stereo mixer signal to another destination like a recording device, personal monitor, subwoofer or to another PA system (Front of House).

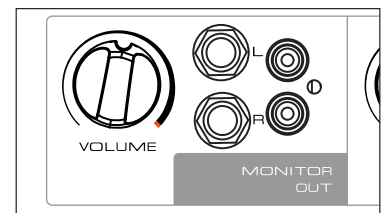

3. HEADPHONE OUTPUT

This 3.5 mm output allows for listening to the mix using headphones.

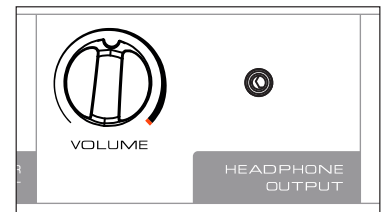

4. SUBWOOFER OUTPUT

This RCA output allows you to connect an additional subwoofer to the solution where added range is necessary.

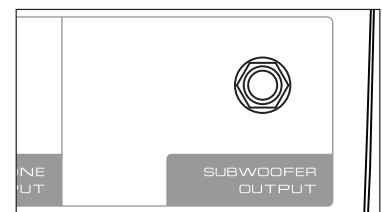

MASTER VOLUME and "Limit" LED

Your EON208P is equipped with a "Master Volume" that controls the overall output volume of the system and a yellow LED that indicates that you have approached the maximum output. In addition to the limited LED, signal meters are also displayed for each output channel.

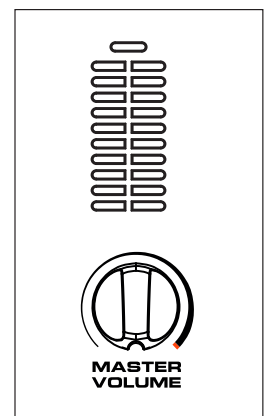

Section 5: System Specifications

EON208P

Main Features	Proven JBL sound quality		
	Bluetooth® streaming audio		
	Ergonomic design with internal cable storage		
System	System Type:	Portable 2-way full-range loudspeakers with powered mixer	
	Maximum SPL Output:	121 dB peak	
	AC input :	100-120 V, 220-240 V 50/60 Hz	
Amplifier	Design:	Class D	
	System Power Rating:	300 W (2x 150 W stereo)	
	Output Connector:	2 x 1/4" TS (unbalanced) amplifier outputs	
Mixer	Channels:	1-4: XLR/1/4" jack combo connectors; 5-6: one pair of 1/4" balanced TRS jacks (stereo), and one pair of RCA jacks (stereo); 7-8: one pair of 1/4" balanced TRS jacks (stereo), and a 3.5mm stereo jack	
	Phantom Power:	CH1 and CH2 have phantom power control and share the same selection switch	
	Hi-Z Selection:	CH3 has a Hi-Z selection switch used for guitar signal input	
	Output Connectors:	Monitor Out: one pair of RCA jacks (stereo), and one pair of 1/4" balanced TRS jacks (stereo) Headphone Out: 3.5mm stereo jack Subwoofer Out: 1/4" balanced TRS jack	
	Treble/Bass EQ:	Per-channel high- and low-shelf filters; +/- 12dB cut and boost	
	System Limiter:	On-board DSP limiting	
	Speaker	LF Driver:	1x JBL 8" (203mm) woofer
		HF Driver:	1x 1" Neodymium black aluminum dome tweeter
		Coverage Pattern:	100° horizontal x 60° vertical
Crossover Frequency:		2 kHz	
Crossover Type:		2-way passive network, 2nd order filters (12dB cutoff per octave)	
Enclosure:		Polypropylene	
Suspension/Mounting:		36 mm pole socket	
Handles:		One on top	
Grille:		Powder-coated perforated steel	
Shipping Package Dimensions (H x W x D):	22.6" x 30.5" x 15.7" (575 mm x 775 mm x 400 mm)		
Net Weight of System:	17.6 kg (38.8 lbs)		

Section 6: Cables and Connectors

XLR/F to XLR/M Microphone Cable	The standard cable for interconnection of microphone and line level signal in professional audio systems. • Microphone to mixer
TRS (balanced) 1/4 inch phone jack to XLR/M	For connecting balanced devices with 1/4 inch phone and maybe used interchangeably.
TRS (unbalanced) 1/4 inch phone jack to XLR/M	For connections of instruments with unbalanced outputs to balanced XLR inputs.
TS (unbalanced) 1/4 inch phone jack to XLR/M	This cable is electrically identical to "TRS" (unbalanced) 1/4 inch phone and may be used interchangeably.
XLR/M to RCA (phono) cable	Connects consumer audio products and some DJ mixer outputs to professional audio equipment inputs
TRS 1/4 inch Phone jack to dual 1/4 inch Phone jack	Splits a stereo output into separate left/right signals.
TRS 1/4 inch Phone jack to dual 1/4 inch Phone jack	Change to a TRS mini-phone jack to connect to the output of a portable. MP3/CD – player and computer sound cards to a mixer.
XLR/F to XLR/M audio ground lift	Only with balanced in - and outputs

XLR/F to XLR/M Microphone Cable

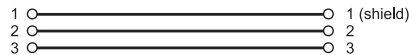

TRS (Balanced) 1/4" Phone to XLR/M Cable



TRS (Unbalanced) 1/4" Phone to XLR/M Cable

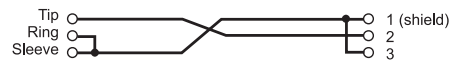

TS (Unbalanced) 1/4" Phone to XLR/M Cable

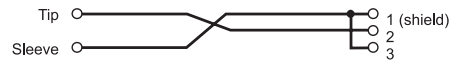

XLR/M to RCA (phono) Cable

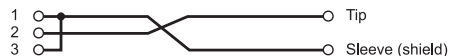

TS (Unbalanced) 1/4" Phone to RCA (phono) Cable

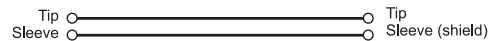

TRS 1/4" Phone to dual TS 1/4" Phone

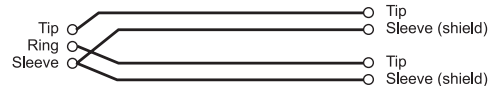

XLR/F to XLR/M Audio Ground Lift

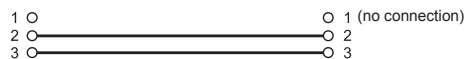
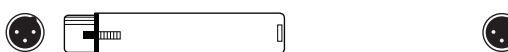

Section 7: Contact Information



Mailing Address:

JBL Professional
8500 Balboa Blvd.
Northridge, CA 91329

Shipping Address:

JBL Professional
8500 Balboa Blvd., Dock 15
Northridge, CA 91329

(Do not return product to this address without first obtaining prior authorization from JBL)

Customer Service:

Monday through Friday
8:00am - 5:00pm
Pacific Coast Time in the U.S.A.
(800) 8JBLPRO (800.852.5776)
www.jblproservice.com

On The World Wide Web:

www.jblpro.com

Professional Contacts, Outside the USA:

Contact the JBL Professional Distributor in your area. A complete list of JBL Professional international distributors is provided at our U.S.A. website: www.jblpro.com

Product Registration:

Register your product online at www.jblpro.com

Section 8: Warranty Information

The JBL Limited Warranty on professional loudspeaker products (except for enclosures) remains in effect for five years from the date of the first consumer purchase. JBL amplifiers are warranted for three years from the date of original purchase. Enclosures and all other JBL products are warranted for two years from the date of original purchase.

Who Is Protected by This Warranty?

Your JBL Warranty protects the original owner and all subsequent owners so long as: A.) Your JBL product has been purchased in the Continental United States, Hawaii or Alaska. (This Warranty does not apply to JBL products purchased elsewhere except for purchases by military outlets. Other purchasers should contact the local JBL distributor for warranty information.); and B.) The original dated bill of sale is presented whenever warranty service is required.

What Does the JBL Warranty Cover?

Except as specified below, your JBL Warranty covers all defects in material and workmanship. The following are not covered: Damage caused by accident, misuse, abuse, product modification or neglect; damage occurring during shipment; damage resulting from failure to follow instructions contained in your Instruction Manual; damage resulting from the performance of repairs by someone not authorized by JBL; claims based upon any misrepresentations by the seller; any JBL product on which the serial number has been defaced, modified or removed.

Who Pays for What?

JBL will pay all labor and material expenses for all repairs covered by this warranty. Please be sure to save the original shipping cartons because a charge will be made if replacement cartons are requested. Payment of shipping charges is discussed in the next section of this warranty.

How to Obtain Warranty Performance

If your JBL product ever needs service, write or telephone us at JBL Incorporated (Attn: Customer Service Department), 8500 Balboa Boulevard, PO. Box 2200, Northridge, California 91329 (818-893-8411). We may direct you to an authorized JBL Service Agency or ask you to send your unit to the factory for repair. Either way, you'll need to present the original bill of sale to establish the date of purchase. Please do not ship your JBL product to the factory without prior authorization. If transportation of your JBL product presents any unusual difficulties, please advise us and we may make special arrangements with you. Otherwise, you are responsible for transporting your product for repair or arranging for its transportation and for payment of any initial shipping charges. However, we will pay the return shipping charges if repairs are covered by the warranty.

Limitation of Implied Warranties

ALL IMPLIED WARRANTIES, INCLUDING WARRANTIES OF MERCHANTABILITY AND FITNESS FOR PARTICULAR PURPOSE, ARE LIMITED IN DURATION TO THE LENGTH OF THIS WARRANTY.

EXCLUSION OF CERTAIN DAMAGES

JBL'S LIABILITY IS LIMITED TO THE REPAIR OR REPLACEMENT, AT OUR OPTION, OF ANY DEFECTIVE PRODUCT AND SHALL NOT INCLUDE INCIDENTAL OR CONSEQUENTIAL DAMAGES OF ANY KIND. SOME STATES DO NOT ALLOW LIMITATIONS ON HOW LONG AN IMPLIED WARRANTY LASTS AND/OR DO NOT ALLOW THE EXCLUSION OF INCIDENTAL OR CONSEQUENTIAL DAMAGES, SO THE ABOVE LIMITATIONS AND EXCLUSIONS MAY NOT APPLY TO YOU. THIS WARRANTY GIVES YOU SPECIFIC LEGAL RIGHTS, AND YOU MAY ALSO HAVE OTHER RIGHTS, WHICH VARY, FROM STATE TO STATE.



Part Number: 5001426